

eyebath & eye/facewash e

An extensive range of plumbed-in units to enable continuous flushing with clean cool water, complemented by portable units for use at the scene of a possible incident.



STD-38G

Portable Emergency Eye, Face and Body Shower unit. Incorporating an Optiflex Hand Shower with reinforced hose connected to a 14 litre stainless steel cylinder. When pressurised to 8 bar via a schraeder tyre valve this unit will deliver a copious quantity of water for nearly two minutes. Fitted with pressure gauge and dual action safety valve to prevent over pressurisation and to allow user to vent the cylinder for cleaning and maintenance.

OPTIONAL FITTINGS:

- Sign for wall mounting
- 3 metre length of spring coiled hose
- Eyesaline concentrate



STD-35G

Wall Mounted Emergency Eyebath and Safety Sign. The eyebath attachment is on a flexible hose incorporating a handle, removable eyebath cup and dust cover.

OPTIONAL FITTINGS:

- Additional Fine Mesh Filter



STD-28G

Portable, hand-operated, Emergency Eyebath unit, incorporating a 9 litre stainless steel cylinder with pressure gauge and eyebath diffuser on flexible hose. Capable of delivering a copious quantity of aerated water for two minutes.

Available complete with wall cabinet if specified (see optional fittings below).

OPTIONAL FITTINGS:

- Sign for wall mounting
- Cabinet for wall mounting with sign and green & white safety stripes
- Eyesaline concentrate



optiflex

OPTIFLEX 100

Hand operated Eye, Face and Body Shower with unique lock-on facility. Supplied with a wall mounting bracket that incorporates a dust cover, a flexible 1.5 metre long reinforced hose, a non return valve and a flow regulator.

OPTIONAL FITTINGS:

- Table mounting kit
- Sign for wall mounting
- 3 metre length of spring coiled hose
- Twin spray head (Optiflex 500)



equipment

STD-75G

Wall, Pedestal or Table Mounted
Emergency Eye/Facewash Fountain
with yellow ABS plastic bowl, aerated
diffusers and flow regulator.

With Stainless Steel bowl **STD-85G**
Pedestal mounted models **STD-75G/P**
& **STD-85G/P**

Table/Bench mounted model
STD-85G/T (see page 10)

OPTIONAL FITTINGS:

- Sign for wall mounting
- Optiflex Hand Shower
- Additional Fine Mesh Filter
- Treadle Foot Control
- Proximity Switch



STD-45G

"Unbreakable" Wall, Pedestal or Table
Mounted Emergency Eye/Facewash
Fountain with integral lid, aerated diffusers,
flow regulator and self-adhesive sign.

Pedestal version available in Galvanised or
Stainless Steel.

Pedestal mounted model **STD-45G/P**

Table/Bench mounted model

STD-45G/T (see page 10)

OPTIONAL FITTINGS:

- Sign for wall mounting
- Optiflex Hand Shower
- Additional Fine Mesh Filter
- Treadle Foot Control
- Proximity Switch

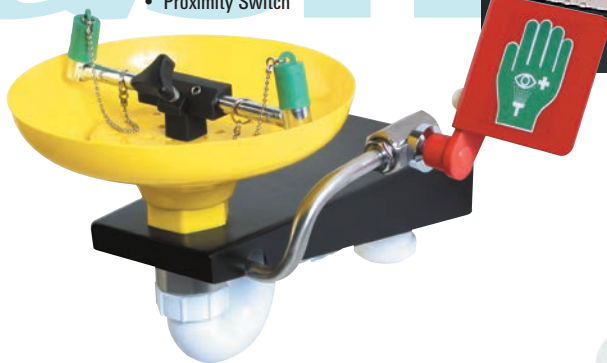

STD-H-25K/P

Pedestal Mounted Emergency
Eyebath/Facewash Fountain, trace tape
heated and pre-insulated. Suitable for
outdoor use. Incorporating an integral
lid connected to the water valve which
automatically operates the unit when
the lid is lifted. The lid also ensures that
the bowl remains clean and free from
contamination at all times and is fitted
with a mirror and first-aid instructions.

With additional eyebath diffuser on
flexible hose to treat unconscious or
disabled personnel.

Available in Galvanised or Stainless
Steel.

OPTIONAL FITTINGS:

- Sign for wall mounting
- Treadle Foot Control
- Proximity Switch
- Cubicle



STD-25K

Wall or Pedestal Mounted Emergency
Eyebath/Facewash Fountain
incorporating an integral lid connected
to the water valve to automatically
operate the unit when the lid is lifted.
The lid also ensures that the bowl
remains clean and free from
contamination at all times and is fitted
with a mirror with first-aid instructions.
With additional eyebath diffuser on
flexible hose to treat unconscious or
disabled personnel.

Available in Galvanised or Stainless
Steel.

Pedestal mounted model **STD-25K/P**

OPTIONAL FITTINGS:

- Sign for wall mounting
- Treadle Foot Control
- Proximity Switch

	Stainless Steel	Depth mm	Width mm	Height mm	Weight kg	Inlet Size (" inches) BSP	Min. Pressure kg/cm ² (bar g)	Water Flow l/min
Eyebaths								
STD-38G	-	220	220	725	5.5	-	8	8
STD-28G	-	180	180	650	3.5	-	7	4.5
Cabinet for 28G	-	240	330	880	5.5	-	-	-
STD-35G	-	115	340	175	2	15mm or 1/2"	1.5	4.5
STD-45G	-	265	340	205	3	15mm or 1/2"	2	20
STD-45G/P	STD-45GS/P	365	340	1175	10	1 1/4"	2	20
STD-25K	STD-25KS	565	475	390	13	1/2"	2.2	30
STD-25K/P	STD-25KS/P	580	475	1130	20	1 1/4"	2.2	30
STD-H-25K/P	STD-H-25KS/P	720	475	1130	26	1 1/4"	2.2	30
STD-75G	STD-85G	400	410	315	3.5	15mm or 1/2"	2	12
STD-75G/P	STD-75GS/P	510	285	1175	8	1 1/4"	2	12
STD-85G/P	STD-85GS/P	510	285	1175	8	1 1/4"	2	12
OPTIFLEX 100	-	70	70	230	1	1/2"	1.5	8

unheated emergency shower

A range of Unheated Emergency Safety Showers and Eyebath/Facewash models, designed for use throughout industry, in all applications not subject to the possibility of freezing or overheating, depending on local ambient conditions.

All units are made up of separate modules to facilitate economic packing and freight.

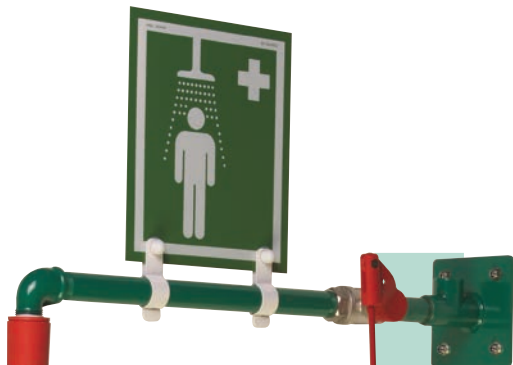

EXP-23G/H

Unheated Wall Mounted Emergency Safety Shower with wall mounting plate.

Available in Galvanised or Stainless Steel.

Note: Available without wall mounting plate - Model EXP-23G

OPTIONAL FITTINGS:

- Sign and Brackets
- Sign for wall mounting
- Plastic or Stainless Steel Shower Rose
- Optiflex Hand Shower
- Light
- Proximity Switch



EXP-23G/V

Unheated Ceiling Mounted Emergency Safety Shower with ceiling mounting plate.

Available in Galvanised or Stainless Steel.

OPTIONAL FITTINGS:

- Sign for wall mounting
- Plastic or Stainless Steel Shower Rose
- Optiflex Hand Shower
- Proximity Switch

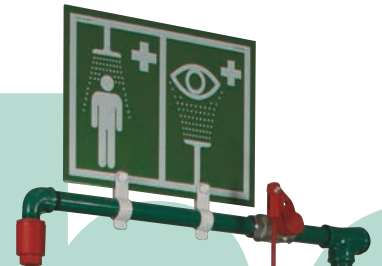

EXP-18G/45G

Unheated Emergency Safety Shower with Eye/Facewash Fountain. With low level water inlet.

Available in Galvanised or Stainless Steel.

Note: Eye/Facewash orientation can be varied to suit clients' requirements.

OPTIONAL FITTINGS:

- Signs and Brackets
- Plastic or Stainless Steel Shower Rose
- Optiflex Hand Shower
- Treadle for Eye/Facewash
- Light
- Proximity Switches
- Cubicle



EXP-18G

Unheated Emergency Safety Shower. Available in Galvanised or Stainless Steel.

OPTIONAL FITTINGS:

- Sign and Brackets
- Plastic or Stainless Steel Shower Rose
- Optiflex Hand Shower
- Foot Panel or Treadle
- Light
- Proximity Switch
- Cubicle



EXP-20G

Unheated Emergency Safety Shower with additional body spray.

Available in Galvanised or Stainless Steel.

OPTIONAL FITTINGS:

- Sign and Brackets
- Plastic or Stainless Steel Shower Rose
- Optiflex Hand Shower
- Foot Panel or Treadle
- Light
- Proximity Switch
- Cubicle



EXP-18G/75G

Unheated Emergency Safety Shower with Eye/Facewash Fountain. With high level water inlet and Eye/Facewash drained to floor level. Available in Galvanised or Stainless Steel.

Note: Eye/Facewash orientation can be varied to suit clients' requirements. Available with Stainless Steel Eye/Facewash bowl **EXP-18G/85G**.

OPTIONAL FITTINGS:

- Signs and Brackets
- Plastic or Stainless Steel Shower Rose
- Treadle for Eye/Facewash
- Light
- Proximity Switches
- Cubicle

EXP-20G/45G

Unheated Emergency Safety Shower with additional body spray and Eye/Facewash Fountain.

With low level water inlet. Available in Galvanised or Stainless Steel.

Note: Also available with Eye/Facewash drain piped to floor level and high level water inlet. Model **EXP-20G/45G-T**.

Note: Eye/Facewash orientation can be varied to suit clients' requirements.

OPTIONAL FITTINGS:

- Signs and Brackets
- Plastic or Stainless Steel Shower Rose
- Optiflex Hand Shower
- Foot Panel or Treadle for Shower
- Treadle for Eye/Facewash
- Light
- Proximity Switches
- Protective Frame

EXP-18G/45G-T

As **EXP-18G/45G** but with Eye/Facewash drain piped to floor level and high level water inlet.

Available in Galvanised or Stainless Steel.

OPTIONAL FITTINGS:

(as **EXP-18G/45G**)

STD-40K

Mobile Emergency Safety Shower with a capacity of approx 114 litres (25 gallons) giving a constant flow of water for about 1½ minutes.

Mobile Emergency Safety Showers are for use when fixed units are not available or are temporarily out of commission.

OPTIONAL FITTINGS:

- Optiflex Hand Shower
- Eye/Facewash **STD-45G**
- A-Frame for towing

PRODUCT INFO

- Unheated models for indoor use
- Free standing, wall or ceiling mounted
- Easy maintenance

TECHNICAL DETAILS

- Separate modules
- Compact packaging
- Cost effective carriage

CHOICES

- Low-level or high-level water inlet
- Body spray
- Eye/Facewash units
- Eye/Facewash drain piped to floor level
- Available with tubulars either of galvanised carbon steel protected by green Hammerite enamel, or alternatively of semi-polished Stainless Steel
- Mobile Model

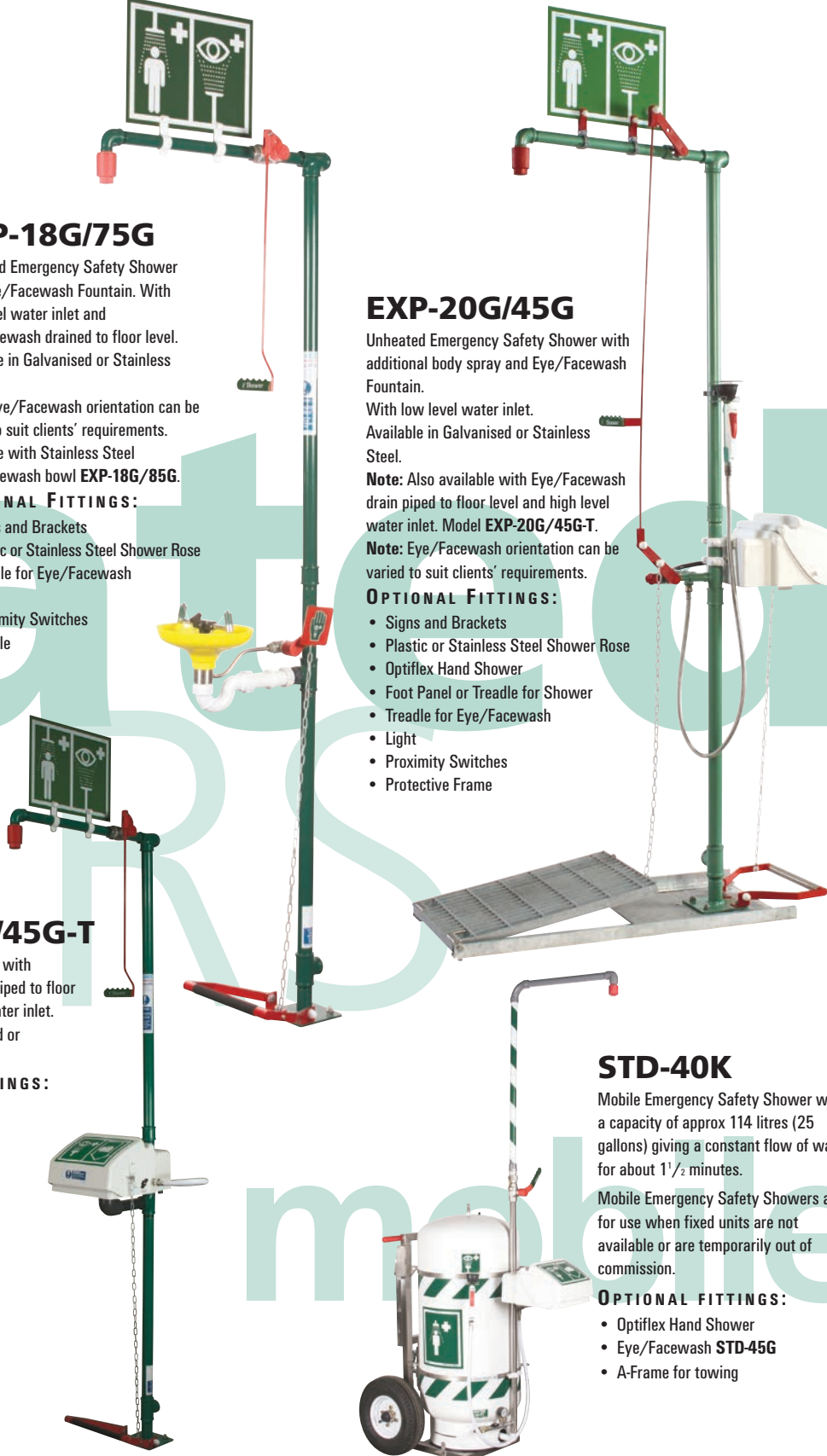

Galvanised	Stainless Steel	Depth mm	Width mm	Height mm	Weight kg	Inlet Size (" inches) BSP	Min. Pressure kg/cm ² (bar g)	Water Flow l/min
Unheated Safety Showers								
EXP-18G	EXP-18GS	750	150	2300	15	1 1/4"	1.5	75
EXP-18G/45G	EXP-18GS/45G	750	340	2300	18	1 1/4"	2	75
EXP-18G/45G-T	EXP-18GS/45G-T	750	340	2330	18	1 1/4"	2	75
EXP-20G	EXP-20GS	1050	460	2300	16	1 1/4"	1.8	115
EXP-20G/45G	EXP-20GS/45G	1180	460	2300	19	1 1/4"	2.2	115
EXP-20G/45G-T	EXP-20GS/45G-T	1180	460	2330	19	1 1/4"	2.2	115
EXP-23G/V	EXP-23GS/V	150	150	370	3.5	1"	1.5	75
EXP-23G/H	EXP-23GS/H	705	150	185	4.5	1"	1.5	75
EXP-23G	EXP-23GS	635	100	130	3	1"	1.5	75
EXP-18G/75G	EXP-18GS/75G	750	285	2330	16	1 1/4"	2	75
EXP-18G/85G	EXP-18GS/85G	750	285	2330	16	1 1/4"	2	75
STD-40K (Stowed dims.)	-	1170	780	1430	105	1/2" Coupling	-	-
STD-40K (Erected dims.)	-	1480	780	2250	220	1/2" Coupling	2	75

STD-40K is a mobile unit. All other units are free standing except EXP-23G/V which is ceiling mounted, and EXP-23G/H which is wall mounted.

self-draining emergency shower

For use outdoors in tropical climates. Fitted with self-draining valves to reduce overheating by solar radiation.

EXP-SD-18G/45G

Self-draining Emergency Safety Shower with Eye/Facewash Fountain. The main shower valve is situated directly above the water inlet and is complete with bleed pipe to drain water from the standpipe to reduce overheating by solar radiation.

Available in Galvanised or Stainless Steel.

OPTIONAL FITTINGS:

- Signs and Brackets
- Plastic or Stainless Steel Shower Rose
- Treadle for Eye/Facewash
- Light
- Proximity Switches
- Cubicle



EXP-SD-18G/25K

Self-draining Emergency Safety Shower with Eyebath/Facewash Fountain. With additional eyebath diffuser on flexible hose to treat unconscious or disabled personnel. The shower and Eyebath/Facewash valves are situated directly above the water inlet and are complete with bleed pipes to drain water from the pipework to reduce overheating by solar radiation.

Available in Galvanised or Stainless Steel.

OPTIONAL FITTINGS:

- Signs and Brackets
- Plastic or Stainless Steel Shower Rose
- Treadle for Eyebath/Facewash
- Light
- Proximity Switches
- Cubicle



EXP-SD-20G

Self-draining Emergency Safety Shower with additional body spray. The main valve is situated directly above the water inlet and is complete with bleed pipe to drain water from the standpipe to reduce overheating by solar radiation. Available in Galvanised or Stainless Steel.

OPTIONAL FITTINGS:

- Sign and Brackets
- Plastic or Stainless Steel Shower Rose
- Foot Panel or Treadle
- Light
- Proximity Switch
- Cubicle

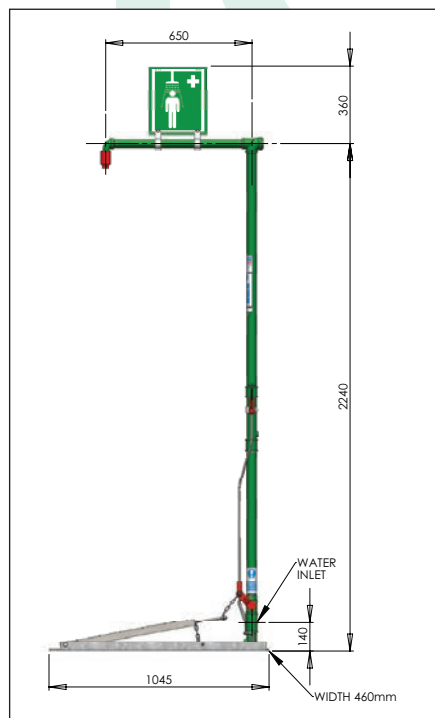
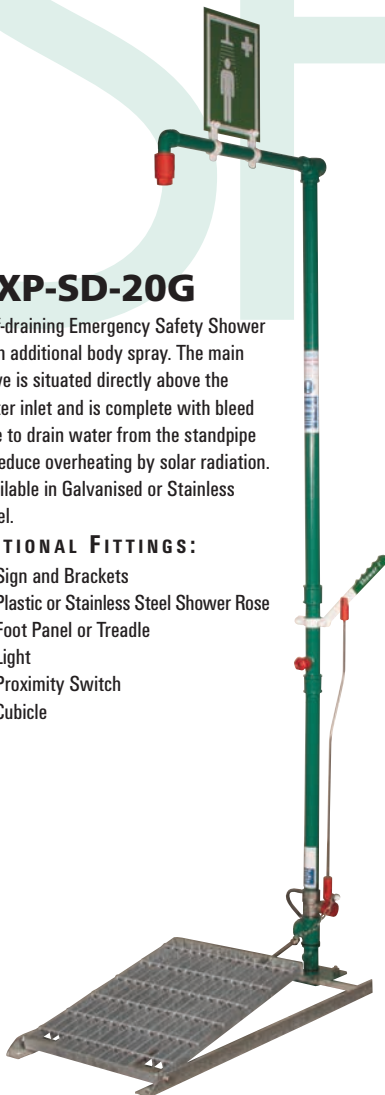

EXP-SD-18G

As EXP-SD-20G but without body spray.

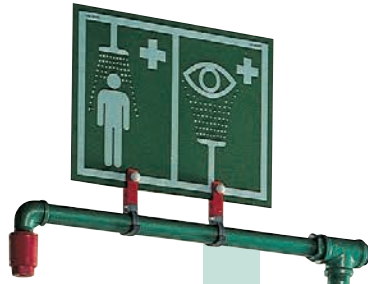

EXP-SD-20G/25K

Self-draining Emergency Safety Shower with additional body spray and Eyebath/Facewash Fountain. With additional eyebath diffuser on flexible hose to treat unconscious or disabled personnel. The shower and eyebath/facewash valves are situated directly above the water inlet and are complete with bleed pipes to drain water from the pipework to reduce overheating by solar radiation. Available in Galvanised or Stainless Steel.

OPTIONAL FITTINGS:

- Signs and Brackets
- Plastic or Stainless Steel Shower Rose
- Foot Panel or Treadle for Shower
- Treadle for Eyebath/Facewash
- Light
- Proximity Switches
- Protective Frame



EXP-SD-20G/45G

Self-draining Emergency Safety Shower with additional body spray and Eye/Facewash Fountain. The main shower valve is situated directly above the water inlet and is complete with bleed pipe to drain water from the standpipe to reduce overheating by solar radiation.

Available in Galvanised or Stainless Steel.

OPTIONAL FITTINGS:

- Signs and Brackets
- Plastic or Stainless Steel Shower Rose
- Foot Panel or Treadle for Shower
- Treadle for Eye/Facewash
- Light
- Proximity Switches
- Protective Frame



PRODUCT INFO

- Self-draining shower valves
- Free standing models
- Separate modules
- Easy maintenance
- Compact packaging
- Cost effective carriage

TECHNICAL DETAILS

- Available with tubulars either of galvanised carbon steel protected by green Hammerite enamel, or alternatively of semi-polished stainless steel

CHOICES

- Body spray
- Eyebath and Facewash units

Galvanised	Stainless Steel	Depth mm	Width mm	Height mm	Weight kg	Inlet Size (" inches) BSP	Min. Pressure kg/cm ² (bar g)	Water Flow l/min
Self-draining showers								
EXP-SD-18G	EXP-SD-18GS	750	425	2260	15	1 1/4"	1.8	75
EXP-SD-20G	EXP-SD-20GS	750	425	2260	16	1 1/4"	1.8	115
EXP-SD-18G/45G	EXP-SD-18GS/45G	750	520	2260	18	1 1/4"	2	75
EXP-SD-18G/25K	EXP-SD-18GS/25KS	750	570	2260	25	1 1/4"	2.2	75
EXP-SD-20G/45G	EXP-SD-20GS/45G	1180	550	2260	19	1 1/4"	2	115
EXP-SD-20G/25K	EXP-SD-20GS/25KS	1390	550	2260	26	1 1/4"	2.2	115

laboratory range

For use in laboratories and clean indoor areas where small spillages of dangerous chemicals cause a hazard to employees



LAB-23GS/H

Wall Mounted Laboratory Shower with shower rose and wall mounting plate.

Note: Available without wall mounting plate - Model LAB-23GS

OPTIONAL FITTINGS:

- Sign for wall mounting
- Hose Mounted Optiflex Eye/Face & Body Shower
- Proximity Switch



LAB-33GS/34G

Wall Mounted Combination Laboratory Shower and Eye/Facewash Fountain with wall mounting plates. The shower has a shower rose and is pull rod operated, whereas the eye/facewash has twin spray nozzles with dust covers and is push plate operated. The water jets lift off the dust covers when operated and the height of the jets is adjustable using an integral flow regulator valve.

Free standing floor mounted model LAB-18GS/34G

OPTIONAL FITTINGS:

- Signs for wall mounting
- Hose Mounted Optiflex Eye/Face & Body Shower
- Proximity Switches

LAB-85GS/T

Table or Bench Mounted Eye/Facewash Fountain with flush fitting bowl and twin spray nozzles fitted with dust covers. The water jets lift off the dust covers when operated and the height of the jets is adjustable using a flow regulator valve. Push plate operated.

Wall mounted model LAB-85GS

Pedestal mounted model LAB-85GS/P

OPTIONAL FITTINGS:

- Sign for wall mounting
- Additional fine mesh filter
- Proximity Switch



LAB-23GS/V

Ceiling Mounted Laboratory Shower with shower rose and ceiling flange.

Note: Made to measure depending on ceiling cavity dimensions.

OPTIONAL FITTINGS:

- Sign for wall mounting
- Proximity Switch
- Ceiling Mounting Kit

PRODUCT INFO

- Unheated models for indoor use
- Wall, ceiling or floor mounted models
- Compact packaging
- Cost effective carriage

TECHNICAL DETAILS

- Powder coated stainless steel shower roses and eye/facewash bowls
- Ground welds on stainless steel models

CHOICES

- Body spray hand shower
- Eye/Facewash unit
- Colour
- Powder coated stainless steel pipework (with 'S' suffix)
- Painted galvanised carbon steel pipework (without 'S' suffix)

STD-45G/T

Table or Bench Mounted 'unbreakable' Eye/Facewash Fountain with integral lid, aerated diffusers, flow regulator and self-adhesive sign.

For Wall or Pedestal mounted models see page 5

OPTIONAL FITTINGS:

- Sign for wall mounting
- Additional fine mesh filter
- Proximity Switch





PRODUCT INFO

- GRP outer casing and lid
- Fully insulated
- Pictogram Signs included

CHOICES

- Green GRP outer casing and lid
- Galvanised or Stainless Steel Frames
- Three sizes available:
350 litre version (-14K/350)
750 litre version (-14K/750)
1200 litre version (-14K/1200)

OPTIONAL FITTINGS

- Non-Flameproof Light
- Zone 1 & 2 Light
- Eye/Facewash Fountain
- Hand Held Eyebath Unit
- Panel Foot Control
- GRP Panelling on legs
- Level Switch
- Proximity Switches
- Syphon Dump Valve
- Visual Level Indicator
- Drain Sump
- Mains Fed Shower System
- Strip Screens
- Shower Doors
- Shower Test Handle
- Audible & Visual Alarms
- Sun Shields



TECHNICAL DATA

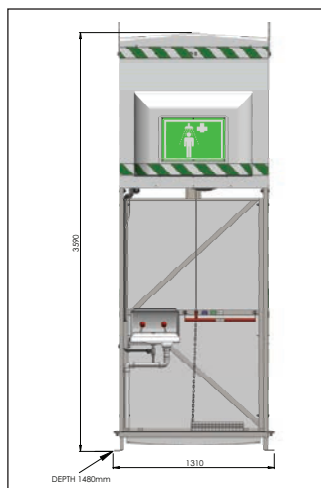
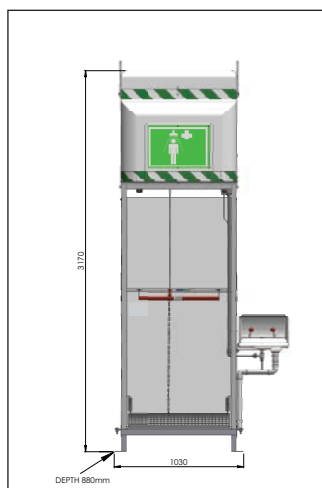

EXP-MH-14K/350

EXP-MH-14K/1200

(EXP-MH-14K/750 as above but 3315mm high)

tank showers

A range of heavy duty Emergency Tank Showers, for use when warm water is required, or a constant supply of water cannot be guaranteed.

These units are essential where there is a problem with

insufficient water pressure or inadequate flow rate.

The outdoor types are heated and pre-insulated to prevent freezing during conditions of frost, whereas the indoor or tropical versions are insulated but without heating, to

ensure a steady temperature is maintained.

Tropical models can be fitted with optional Sun Shields to give extra protection from solar radiation.

Galvanised	Stainless Steel	Depth mm	Width mm	Height mm	Weight kg	Inlet Size (" inches) BSP	Min. Pressure kg/cm ² (bar g)	Water Flow l/min
Lab Range								
LAB-23G/H	LAB-23GS/H	770	260	240	3.5	1"	1.5	75
LAB-23G/V	LAB-23GS/V	260	300	275	2.5	1"	1.5	75
LAB-33G/34G	LAB-33GS/34G	770	260	1400	9	1"	2	75
-	LAB-85GS/T	275	400	160	2.5	3/4"	2	12
STD-45G/T	-	265	340	300	3.5	15mm or 1/2"	2	20
Tank Showers								
EXP-MH-14K/350	EXP-MH-14KS/350	880	1035	3115	150	3/4"	0.5	75
EXP-MH-14K/750	EXP-MH-14KS/750	1480	1320	3315	270	3/4"	0.5	75
EXP-MH-14K/1200	EXP-MH-14KS/1200	1480	1320	3525	320	3/4"	0.5	75
EXP-J-14K/350	EXP-J-14KS/350	880	1035	3115	150	3/4"	0.5	75
EXP-J-14K/750	EXP-J-14KS/750	1480	1320	3315	270	3/4"	0.5	75
EXP-J-14K/1200	EXP-J-14KS/1200	1480	1320	3525	320	3/4"	0.5	75

Indoor or Tropical models are denoted by the prefix -J- prior to the model number ie. EXP-J-14K/350

economy outdoor emergency sh

Designed for use throughout industry, in all applications where there is a possibility of the water inside the shower freezing or overheating due to ambient temperatures.



EXP-EH-2G

Wall Mounted Emergency Safety Shower, trace tape heated and pre-insulated. Complete with a wall mounting plate and alternative water inlet.

Available in Galvanised or Stainless Steel.

EXP-EJ-2G insulated only.

OPTIONAL FITTINGS:

- Sign and Brackets
- Light
- Light Box
- Proximity Switch



EXP-EH-5G

Emergency Safety Shower, trace tape heated and pre-insulated.

Available in Galvanised or Stainless Steel.

EXP-AH-5G extra heating.

EXP-EJ-5G insulated only.

OPTIONAL FITTINGS:

- Sign and Brackets
- Foot Panel or Treadle
- Light
- Light Box
- Proximity Switch
- Underground Extension Pipe
- Cubicle

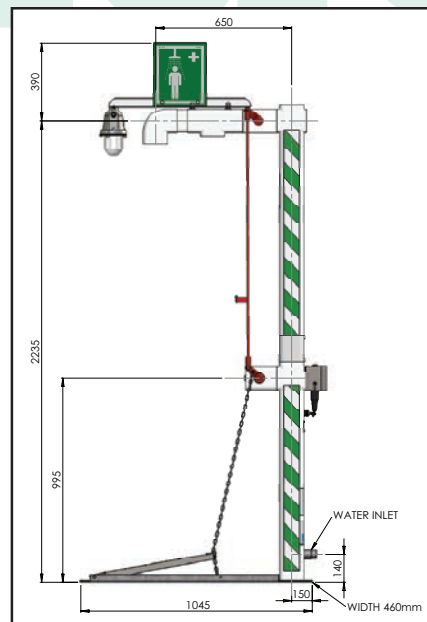

EXP-EH-5G/10G

Emergency Safety Shower with body spray, trace tape heated and pre-insulated.

Available in Galvanised or Stainless Steel.

EXP-AH-5G/10G extra heating.

EXP-EJ-5G/10G insulated only.

OPTIONAL FITTINGS:

- Sign and Brackets
- Light
- Light Box
- Foot Panel or Treadle
- Proximity Switch
- Underground Extension Pipe
- Cubicle



EXP-EH-45G/P

Pedestal Mounted Emergency Eye/Facewash Fountain, trace tape heated and pre-insulated. With 'unbreakable' integral lid, aerated diffusers, flow regulator and self-adhesive sign.

Available in Galvanised or Stainless Steel.

EXP-EJ-45G/P insulated only.

OPTIONAL FITTINGS:

- Sign for wall mounting
- Treadle Foot Control
- Proximity Switch
- Underground Extension Pipe
- Cubicle



PRODUCT INFO

- Heated versions for use in cold climates
- Insulated versions for use in hot climates
- Arctic versions with extra heating for very cold climates
- Wall mounted models
- Free standing models

TECHNICAL DETAILS

- Modular design
- Easy maintenance
- Self-draining removable spray nozzles free from build up of bacteria
- Compact packaging
- Cost effective carriage

CHOICES

- Available in Galvanised or Stainless Steel

EXP-EH-5G/34G

Emergency Safety Shower with Eye/Facewash Diffusers, trace tape heated and pre-insulated.

Available in Galvanised or Stainless Steel.

EXP-AH-5G/34G extra heating.

EXP-EJ-5G/34G insulated only.

OPTIONAL FITTINGS:

- Signs and Brackets
- Treadle Foot Control for eye/facewash
- Light
- Light Box
- Proximity Switches
- Underground Extension Pipe
- Cubicle

**EXP-EH-5G/35G**

Emergency Safety Shower with Eyebath on flexible hose, trace tape heated and pre-insulated.

Available in Galvanised or Stainless Steel.

EXP-AH-5G/35G extra heating.

EXP-EJ-5G/35G insulated only.

OPTIONAL FITTINGS:

- Signs and Brackets
- Treadle Foot Control for eyebath
- Light
- Light Box
- Proximity Switches
- Underground Extension Pipe
- Cubicle

EXP-EH-5G/45G

Emergency Safety Shower with Eye/Facewash Fountain, trace tape heated and pre-insulated.

Available in Galvanised or Stainless Steel.

EXP-AH-5G/45G extra heating.

EXP-EJ-5G/45G insulated only.

OPTIONAL FITTINGS:

- Signs and Brackets
- Treadle Foot Control for eye/facewash
- Light
- Light Box
- Proximity Switches
- Underground Extension Pipe
- Cubicle



Galvanised	Stainless Steel	Depth mm	Width mm	Height mm	Weight kg	Inlet Size (" inches) BSP	Min. Pressure kg/cm ² (bar g)	Water Flow l/min
Heated Emergency Showers								
EXP-EH-2G	EXP-EH-2GS	930	230	230	26	1"	1.5	75
EXP-EH-45G/P	EXP-EH-45GS/P	500	340	1180	26	1 1/4"	2	20
EXP-EH-5G	EXP-EH-5GS	850	150	2310	30	1 1/4"	1.5	75
EXP-EH-5G/10G	EXP-EH-5GS/10GS	850	460	2310	32	1 1/4"	1.8	115
EXP-EH-5G/34G	EXP-EH-5GS/34GS	850	300	2310	32	1 1/4"	2.2	75
EXP-EH-5G/35G	EXP-EH-5GS/35GS	850	240	2310	32	1 1/4"	1.5	75
EXP-EH-5G/45G	EXP-EH-5GS/45GS	850	340	2310	34	1 1/4"	2	75

NOTE: The above models are available with insulation only (no heating) - see description for model numbers.

ALSO: The above models are available with extra trace tape heating in the top section suitable for extremely cold climates (Arctic version EXP-AH-(model No.)).

premium outdoor emergency s

An extensive range of Immersion Heated or Trace Tape Heated models operable in all ambient conditions. Of robust design and including integral light box and pictogram signs.

STD-MH-5K/11K

Premium Emergency Safety Shower, immersion heated and pre-insulated. With Eyebath/Facewash Fountain and additional eyebath diffuser on flexible hose to treat unconscious or disabled personnel.

Available in Galvanised or Stainless Steel.

Trace Tape heated model - **STD-H-5K/11K**

OPTIONAL FITTINGS:

- Foot Treadle for eyebath/facewash
- Zone 1 & 2 Light
- Proximity Switches
- Heated Underground Extension Pipe
- Cubicle

STD-MH-5K

Premium Emergency Safety Shower, immersion heated and pre-insulated.

As 5K/11K but without

Eyebath/Facewash Fountain.

Trace Tape heated model - **STD-H-5K**

STD-MH-6K

Premium Emergency Safety Shower with Eyebath, immersion heated and pre-insulated. The eyebath attachment is on a flexible hose and incorporates a handle, removable eyebath cup and dust cover.

(Eyebath can be located on rear of unit if requested)

Available in Galvanised or Stainless Steel.

Trace Tape heated model - **STD-H-6K**

OPTIONAL FITTINGS:

- Zone 1 & 2 Light
- Proximity Switches
- Heated Underground Extension Pipe
- Cubicle



STD-MH-5K/11K



STD-H-1K

Wall mounted Emergency Safety Shower unit with Eyebath attachment, trace tape heated and pre-insulated. The eyebath attachment is on a flexible hose and incorporates a handle, removable eyebath cup and dust cover. This unit also features a wall mounting plate and has an alternative water inlet.

Available in Galvanised or Stainless Steel.

OPTIONAL FITTINGS:

- Zone 1 & 2 Light
- Proximity Switches



STD-H-2K

Wall mounted Emergency Safety Shower unit, trace tape heated and pre-insulated. This unit also features a wall mounting plate and has an alternative water inlet.

Available in Galvanised or Stainless Steel.

OPTIONAL FITTINGS:

- Zone 1 & 2 Light
- Proximity Switch

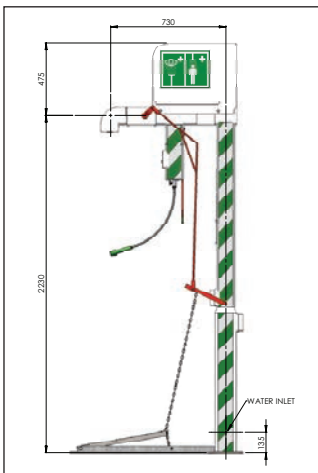

STD-MH-6K

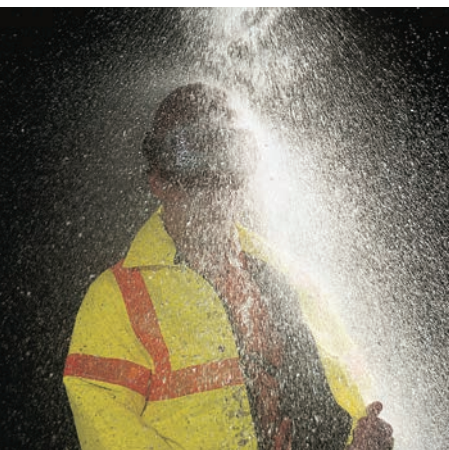

Proximity switch detail

owers



STD-MH-15K

Premium Emergency Safety Shower with additional Body Spray, immersion heated and pre-insulated. Available in Galvanised or Stainless Steel.

Trace Tape heated model - **STD-H-15K**

OPTIONAL FITTINGS:

- Foot Panel
- Zone 1 & 2 Light
- Proximity Switch
- Heated Underground Extension Pipe
- Cubicle

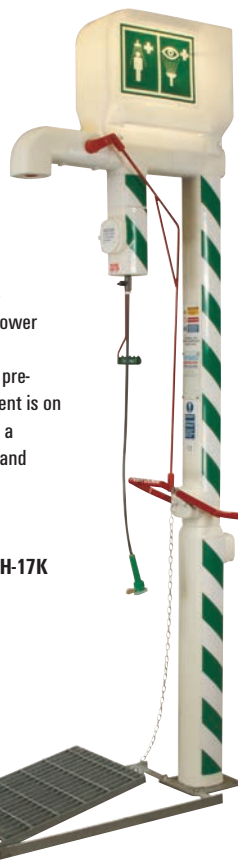

STD-MH-17K

Premium Emergency Safety Shower with additional Body Spray and Eyebath, immersion heated and pre-insulated. The Eyebath attachment is on a flexible hose and incorporates a handle, removable eyebath cup and dust cover.

Available in Galvanised or Stainless Steel.

Trace Tape heated model - **STD-H-17K**

OPTIONAL FITTINGS:

- Foot Panel
- Zone 1 & 2 Light
- Proximity Switches
- Heated Underground Extension Pipe
- Cubicle



STD-MH-15K/11K

Premium Emergency Safety Shower with additional Body Spray, immersion heated and pre-insulated. With Eyebath/Facewash Fountain and additional eyebath diffuser on flexible hose to treat unconscious or disabled personnel. Available in Galvanised or Stainless Steel.

Trace Tape heated model - **STD-H-15K/11K**

OPTIONAL FITTINGS:

- Foot Panel
- Foot Treadle
- Zone 1 & 2 Light
- Proximity Switches
- Heated Underground Extension Pipe
- Protective Frame

PRODUCT INFO

- Rotationally moulded unbreakable white polyethylene outer casing
- Integral Light Box
- Self-draining removable spray nozzles free from build-up of bacteria
- Heated versions for use in cold climates.
- Insulated versions for use in hot climates.
- Robust construction
- Wall mounted models
- Free standing models

TECHNICAL DETAILS

- Modular design
- Easy maintenance

CHOICES

- Available in Galvanised or Stainless Steel

Galvanised	Stainless Steel	Depth mm	Width mm	Height mm	Weight kg	Inlet Size (" inches) BSP	Min. Pressure kg/cm ² (bar g)	Water Flow l/min
Premium Heated Emergency Showers								
STD-H-1K	STD-H-1KS	975	255	910	25	1"	1.5	75
STD-H-2K	STD-H-2KS	975	255	590	20	1"	1.5	75
STD-MH-5K	STD-MH-5KS	835	325	2705	60	1 1/4"	1.5	75
STD-H-5K	STD-H-5KS	835	325	2705	60	1 1/4"	1.5	75
STD-MH-6K	STD-MH-6KS	835	325	2705	70	1 1/4"	1.5	75
STD-H-6K	STD-H-6KS	835	325	2705	70	1 1/4"	1.5	75
STD-MH-5K/11K	STD-MH-5KS/11KS	855	480	2705	55	1 1/4"	2.2	75
STD-H-5K/11K	STD-H-5KS/11KS	855	480	2705	55	1 1/4"	2.2	75
STD-MH-15K	STD-MH-15KS	890	460	2705	90	1 1/2"	1.8	115
STD-H-15K	STD-H-15KS	890	460	2705	90	1 1/2"	1.8	115
STD-MH-17K	STD-MH-17KS	890	460	2705	95	1 1/2"	1.8	115
STD-H-17K	STD-H-17KS	890	460	2705	95	1 1/2"	1.8	115
STD-MH-15K/11K	STD-MH-15KS/11KS	1315	480	2705	106	1 1/2"	2.2	115
STD-H-15K/11K	STD-H-15KS/11KS	1315	480	2705	106	1 1/2"	2.2	115

Note: All above models available with insulation only (no heating) STD-J-(model No.)

temperature controlled showers and shower cubicles

Temperature Controlled Showers and Shower Cubicles have been developed for use in cold climates where it is necessary to maintain a tepid showering temperature or provide a warm environment for showering.

TEMPERATURE CONTROLLED SHOWER CUBICLE

The Temperature Controlled Shower Cubicle is designed for outdoor use in exposed freezing conditions. The cubicle is fitted with a thermostatically controlled air heater and is pre-insulated to help maintain a warm internal temperature.

Push open doors give unimpeded access and automatically close behind the casualty on entry. Windows in the doors enable the casualty to be monitored whilst using the shower which is imperative in case assistance is required.



STD-TC-100K/11K

The Temperature Controlled (TC) Emergency Safety Shower is intended for outdoor use where the water requires heating. It has a 300 litre tank and 3kW heater and regardless of the ambient temperature will deliver tepid water for the ANSI recommended minimum period of 15 minutes. Water from the heated tank is mixed with the mains fed cold supply through a high flow rate thermostatically controlled valve to maintain a temperature of between 25 to 35°C.

In addition to delivering water at the required temperature through its own shower head, the TC unit can also supply heated water to other Emergency Showers via a second outlet from the tank. This means that several showers within an area can meet the temperature and duration criteria stipulated in the ANSI standard.

A side mounted Eyewash/Facewash can be supplied. A temperature controlled unit can be provided just to supply heated water to other shower and eyewash units.

OPTIONAL FITTINGS:

- Foot Panel for shower
- Foot Treadle for eyewash/facewash
- Non Flameproof Light
- Zone 1 & 2 Light
- Light Box
- Proximity Switches
- Heated Underground Extension Pipe
- Protective Frame



cubicles and frames

Cubicles and Protective Frames have been designed for situations where an Emergency Shower needs its own floor space, particularly if space is at a premium. They protect against damage and prevent clutter around the Shower and Eyebath/Facewash and ensure accessibility in an emergency.



CUBICLE WITH SUMP

Heavy duty Shower Cubicle with an integral drain sump. Galvanised and painted mild steel rectangular hollow section frame with white GRP panelling and holding down lugs. With self-adhesive pictogram 'Shower' and/or 'Eye Wash' signs and green and white safety stripes.

Size and orientation of drain outlet to suit customer requirements (2" BSP standard).

OPTIONAL FITTINGS:

- Semi-polished stainless steel frame
- Green GRP panelling
- Clear polycarbonate panelling
- Stainless steel panelling
- Flexible PVC strip screens fitted to entrance
- Light Box
- Extra large Cubicles available to suit eye/facewash on side of shower facing forward

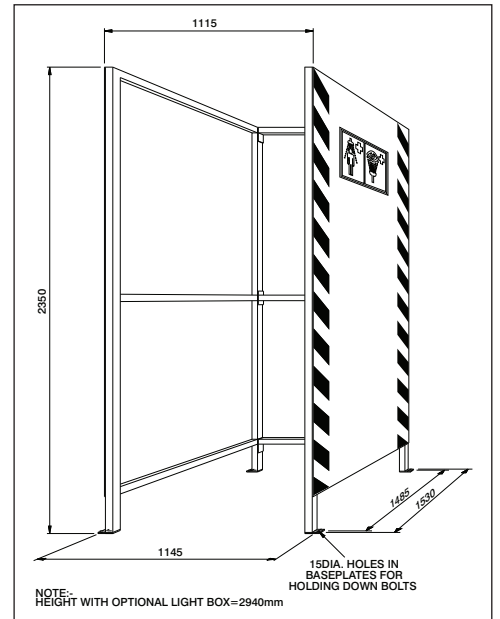

CUBICLE

Heavy duty Shower Cubicle. Galvanised and painted mild steel rectangular hollow section frame with white GRP panelling and holding down lugs. With self-adhesive pictogram 'Shower' and/or 'Eye Wash' signs and green and white safety stripes.

OPTIONAL FITTINGS:

- Semi-polished stainless steel frame
- Green GRP panelling
- Clear polycarbonate panelling
- Stainless steel panelling
- Flexible PVC strip screens fitted to entrance
- Light Box
- Extra large Cubicles available to suit eye/facewash on side of shower facing forward

PROTECTIVE FRAME

Galvanised and painted mild steel rectangular hollow section frame with foot grating incorporating Panel Type Foot Control. Top of frame sheeted with white GRP sheet bearing green and white safety stripes and pictogram 'Shower' and 'Eye Wash' signs.

OPTIONAL FITTINGS:

- Semi-polished stainless steel frame
- Green GRP panelling
- Panelling on two sides
- Panelling on three sides
- Stainless steel panelling
- Flexible PVC strip screens fitted to entrance and/or sides
- Light Box
- Extra large Frames available to suit eye/facewash on side of shower facing forward



TECHNICAL DETAILS

A choice of materials and colours are available for the panelling, and the frames can be manufactured in either stainless steel or galvanised mild steel which is over-painted with silver Hammerite paint.

	Depth mm	Width mm	Height mm	Weight kg	Inlet Size (" inches) BSP	Outlet Size (" inches) BSP	Min. Pressure kg/cm ² (bar g)	Water Flow l/min
Temperature Controlled Showers								
STD-TC-100K/11K	1625	1275	2710	235	1/4"	-	2.2	75
Temperature Controlled Shower Cubicle	1595	1370	2600	350 (approx)	-	2"	-	-
Cubicles and Protective Frames								
Cubicle with sump	1530	1115	2350	240	-	2"	-	-
Protective Frame	1300	1000	2700	180	-	-	-	-
Cubicle	1530	1115	2350	75	-	-	-	-

ppe decontamination showers

A selection of Decontamination Showers used for the effective decontamination of Personal Protective Equipment.

ppe decontamination



DEC-V-5

Two stage Decontamination Shower with detergent application followed by wash down shower action. Incorporating a detergent inducing venturi feeding an overhead shower rose and hose brush, and 10 shower nozzle and hose brush, and 10 shower nozzles for the secondary wash down. Available with Stainless Steel pipework **DEC-V-5S**.

OPTIONAL FITTINGS:

- Drain Sump
- Flexible PVC strip screens fitted to entrance
- 38mm lay-flat delivery hose
- Galvanised painted panelling
- Stainless steel panelling
- Aluminium panelling



DEC-D-29

Basically similar to the Venturi Shower, but does not incorporate the venturi detergent inducer.

Available with Stainless Steel pipework **DEC-D-29S**.

OPTIONAL FITTINGS:

- Drain Sump
- Flexible PVC strip screens fitted to entrance
- 38mm lay-flat delivery hose
- Galvanised painted panelling
- Stainless steel panelling
- Aluminium panelling



DEC-V-1

Wall mounted Decontamination Shower with venturi detergent inducer. With tubulars manufactured from stainless steel milk tubing. For use in clean areas typically found in the pharmaceutical industry.

DEC-V-2

Wall mounted Decontamination Shower with venturi detergent inducer. With tubulars manufactured from stainless steel standard tubing.

DEC-V-3

Wall mounted Decontamination Shower with venturi detergent inducer. With tubulars manufactured from galvanised and painted carbon steel tubing.



When the location is of a temporary nature these units can be easily sited by Fork Lift Truck and connected to the water main by using 38mm lay-flat delivery hose.



STD-SD-32K

STD-SD-31K/V

PRODUCT INFO

Three basic models:
STD-SD-32K - a simple Emergency Shower with overhead spray and optional body spray.
STD-SD-31K - a simple Decontamination Shower with a multi-nozzle spray system.
STD-SD-31K/V a two stage Decontamination Unit incorporating a detergent inducer.

OPTIONAL FITTINGS

- Body Spray (32K only)
- Eye/Facewash **STD-45G**
- Optiflex Hand Shower
- Panel Foot Control (not 31K/V)
- Strip Screens
- Shower Door
- Light
- Proximity Switches
- Brush on hose (31K/V only)

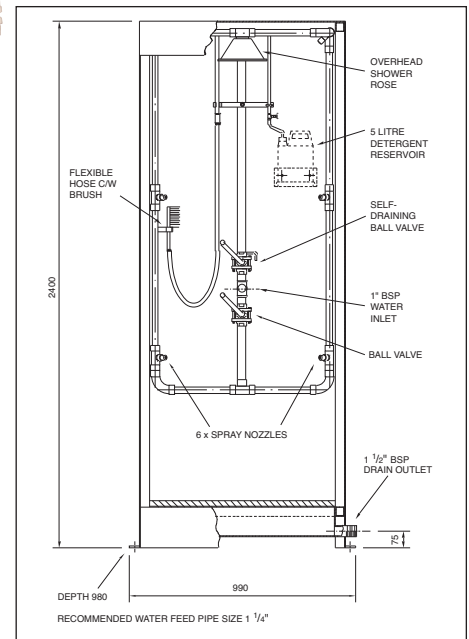

STD-SD-31K

cubicle showers

These cubicle models are ideal in situations where a shower needs to be totally enclosed, particularly if space is at a premium or where a shower requires its own designated area due to clutter. Also very popular where it is imperative that there is no overspray of water outside the shower area.

Galvanised	Stainless Steel	Depth mm	Width mm	Height mm	Weight kg	Inlet Size (" inches) BSP	Outlet Size (" inches) BSP	Min. Pressure kg/cm ² (bar g)	Water Flow l/min
PPE Decontamination Showers									
DEC-V-5	DEC-V-5S	1110	1300	2400	160	1 1/2"	-	4	250
DEC-D-29	DEC-D-29S	1110	1300	2400	150	1 1/4"	-	4	250
-	DEC-V-1	920	900	1540	20	3/4"	-	2.8	60
-	DEC-V-2	920	900	1540	20	3/4"	-	2.8	60
DEC-V-3	-	920	900	1540	20	3/4"	-	2.8	60
Cubicle Showers									
STD-SD-32K		980	900	2400	150	1"	1 1/2"	2	75
STD-SD-31K		980	900	2400	150	1"	1 1/2"	2	126
STD-SD-31K/V		980	900	2400	150	1"	1 1/2"	2	126